



CS 80 MAGNEO

Automatic sliding
door operator

CS 80 MAGNEO – An unrivalled automatic sliding door operator.

The CS 80 MAGNEO is excelled by its high comfort and outstanding driving performance. Based on magnetic technology from DORMA, this door operator system enables single-panel sliding doors to be used in the interior of buildings without difficulty and in any application. The interior of every building – no matter if public or commercial building or private home – will benefit from the system's slender construction and the timeless and elegant DORMA Contur Design.

Suddenly anything is possible

Thanks to the flexibility of this new system, the CS 80 MAGNEO opens up various fields of application – both in the private and the commercial sector. No matter if installed as interior door, as access door of a walk-in cupboard or as prestigious entrance door to an office or practice, the CS 80 MAGNEO is extremely versatile as it is suitable for in-wall or on-wall mounting and may be realised as left- or right-handed version. For professionals and competent laymen, this automatic sliding door operator is straightforward to install and easy to operate, making it a preferred application, especially as also existing door systems may be upgraded with the aid of the automatic CS 80 MAGNEO operator.

Safe – CS 80 MAGNEO

In Low-Energy-Mode, extra-sensitive driving characteristics respond immediately to any obstacle, thereby ensuring excellent protection as a rule. Additional safety sensors may not be required as the sliding door operator, if realised as Low-Energy application in accordance with DIN 18650 (German Industrial Standard), ANSI (American Standard) and BSI (British Standard), may even be operated without sensors. When Full-Energy-Mode is activated at the operator, the CS 80 MAGNEO benefits from seamless integration in the DORMA system. In this case, the CS 80 MAGNEO must be equipped with optional safety sensors from the DORMA Automatic range of accessories.

Functions

No matter if you would like to open the door in a full-automatic way via motion detector, manually, via pushbutton or if you would like to adjust the door so that it is permanently open, the CS 80 MAGNEO already provides a large range of standard functions. It may be activated via pushbutton, radar motion detector, radio remote control, Push&Go, manually and adjusted to Permanent Open Function or Full-Energy-Mode (in Full-Energy Mode additional safety sensors are required).

Mounting

In many cases, mounting the CS 80 MAGNEO does not require any specialist knowledge. Comprehensive mounting and operating instructions mean that the mounting be performed by the glass, metal and timber worker or the competent layman.





Magnetic technology is silent. MAGNEO will give the proof.

A technology is suitable for everyday business if you hardly notice it: thanks to its almost noiseless and reliable function.

The CS 80 MAGNEO is driven by the magnetic and thus contactless shear wave of a linear DC motor – a movement that perfectly

matches the movement of a sliding door. The functional principle of the CS 80 MAGNEO is simple: Its silent operating

behaviour makes the system especially suitable for areas where a low noise level is required: Everywhere.

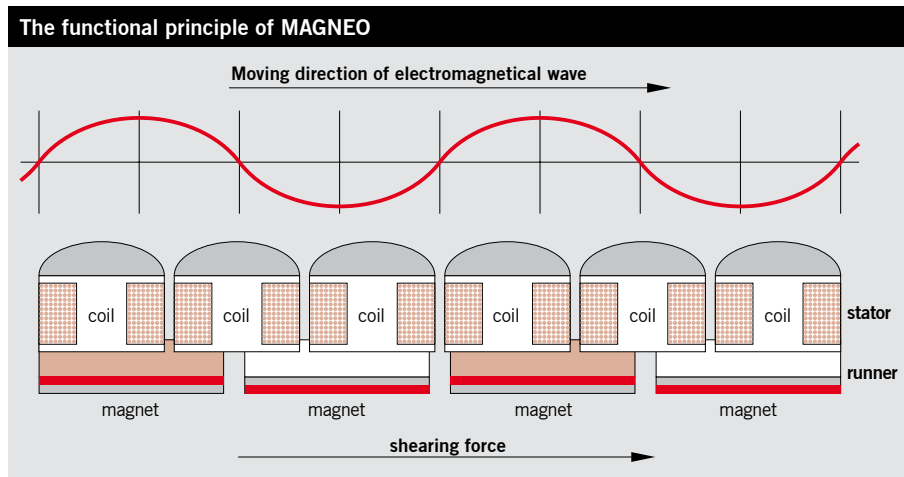

CS 80 MAGNEO – Our modular system appears to be that simple. It is!

CS 80 MAGNEO is a modular system consisting of door kits, cover and fixings kits, the CS 80 MAGNEO operator and accessories. The system allows virtually any door to be configured as an automatic sliding door. The overview right illustrates which system components are required.

The respective door kits contain all components that are required to mount the CS 80 MAGNEO operator onto the door panel for the prevailing way of mounting.

You will require an additional cover and fixing set if you want to mount the CS 80 MAGNEO operator on the wall.

The CS 80 MAGNEO operator is the basis for any application. It is available in three lengths in order to cover different door widths.

Wooden door/frame door (on-wall)









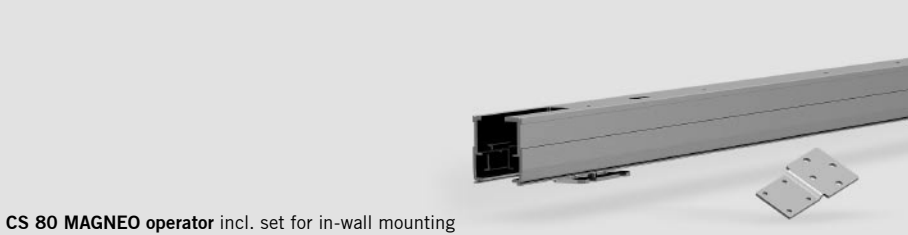
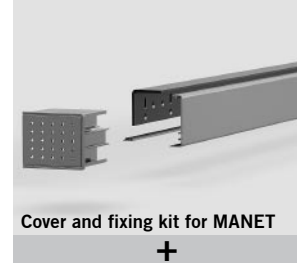

Glass door/glass clamping rail (on-wall)



Glass door/ MANET single-point fixings (on-wall)

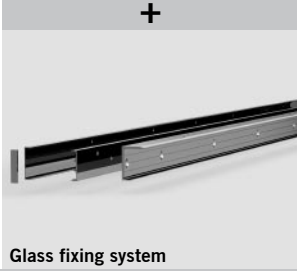
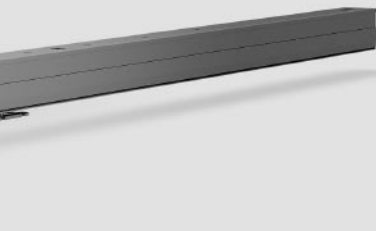

Glass door/ MANET single-point fixings*1 (on glass wall)	Wooden door/frame door (in-wall)	Glass door/glass clamping rail (in-wall)	Glass door/ MANET single-point fixings*2 (in-wall)	
				
 Door kit MANET	 Door kit for wooden door panel	 Door kit glass clamping rail	 Door kit MANET	
+				
 Glass fixing system	+	+	+	
				

*1 Planning and mounting by a specialist firm only *2 This application does not comply with European Union standards. There is a risk of injury in the panel-suspension area.

Ways of mounting

- In-wall mounting
- On-wall mounting

Passage widths

- From 650 to 1,060 mm.
- The CS 80 MAGNEO operator, the fixing kit and cover kit as well as the glass clamping rail kit are available in three different lengths.

Available door panel versions

- Full-glass doors
 - Framed glass doors
 - Wooden doors (solid-leaf construction)
 - Metal doors
 - For door panel weights from 20 to 80 kg
- The door panel must be ordered separately.

Activation of opening/closing cycle

- Full-automatic via motion detector
- Via touch (Push&Go)
- Pushbutton
- Hand-held transmitter

Self-service provides high comfort.



The CS 80 MAGNEO is easy to handle. This automatic sliding door operator offers all important standard functions and various special functions for your convenience.

User comfort that will open doors for you: either in a full automatic way via motion detector, pushbutton (either with cable or wireless), radio remote control or with the

aid of our smooth Push&Go Function. No matter how you open the door – all functions are freely selectable: the hold-open time, Permanent Open and automatic closing.

Very simple and simply beautiful!

Series functions as standard.



Push&Go

The door opens as soon as the door is slightly pushed in opening direction by hand and closes automatically on expiry of the individually adjustable hold-open time.



Manual access

Although the CS 80 MAGNEO is a full-automatic operator, it may effortlessly be opened and closed manually in the event of a power failure.



“SoftMotion“ safety

The system is delivered in Low-Energy-Mode as standard so that the door will stop and reverse automatically on the slightest contact.

Plenty of accessories for those who want even more



Pushbutton

The CS 80 MAGNEO is activated via pushbutton. The sliding door will close automatically as soon as the user has passed the door system.



Radio remote control

A CS 80 MAGNEO operator with a RC radio remote system may be opened and closed with the aid of a RC-H radio remote control.



Motion detector

An ArtMotion motion detector is suitable to open the CS 80 MAGNEO in a full-automatic way.

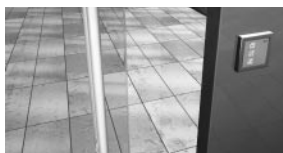

Program switch

You may comfortably switch between the different operation modes (Automatic, Permanent Open and manual operation) with the aid of the internal program switch or the wall-mounted EPS-S3 program switch.

Please have a look at our CS 80 MAGNEO planning aid leaflet for further assistance during the planning your door system. If you are interested in this leaflet please contact your DORMA specialist dealer or visit us on the internet www.dorma-magneo.com.

A folding rule is enough to plan the system.



Operator length and driving path

The length of the CS 80 MAGNEO operator depends on the length of the door's driving path (F) – which describes the distance the door has to cover for its opening or closing cycle. The respective formula is blindingly easy:

$$\text{Passage width DB} + \text{Door panel projection } A^B = \text{Driving path F}$$

Available lengths LV 1-3

We offer the CS 80 MAGNEO in three different lengths:
LV1 for driving paths F of up to 875 mm,
LV2 for driving paths F of up to 1,000 mm,
LV3 for driving paths F of up to 1,125 mm.

A^B = door panel projection

The door panel projection is freely selectable. It may however not exceed 65 mm and is calculated with the aid of the passage width DB and the door panel width B:
 $(\text{Door width B} - \text{DB}) / 2 = A^B$

Place requirement for operator including covers

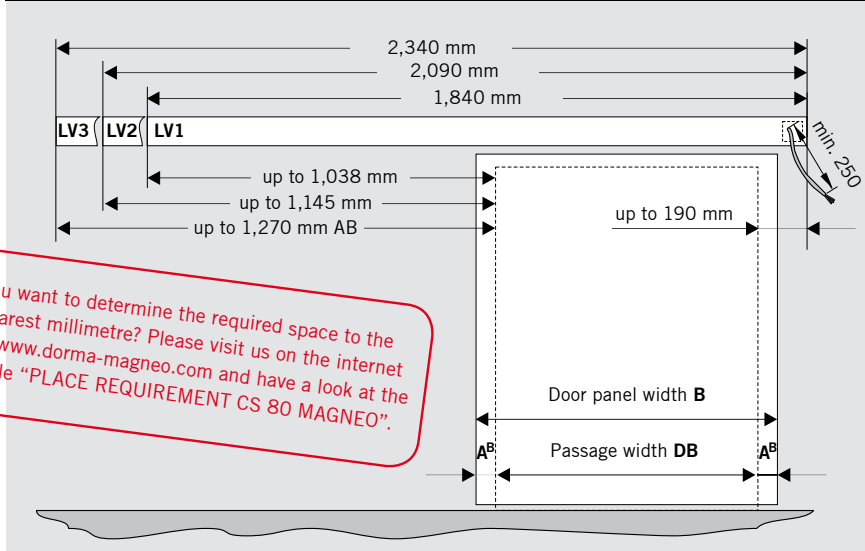

The sliding door on the drawing opens to the left side, thus the power supply is connected on the right side of the door (mains connection 3 x 1.5 mm²). The power supply of door systems opening to the right thus has to be realised on the left side of the operator.

You want to determine the required space to the nearest millimetre? Please visit us on the internet at www.dorma-magneo.com and have a look at the table "PLACE REQUIREMENT CS 80 MAGNEO".

Reach your target with the proper dimensions.

On-wall mounting	In-wall mounting
Power supply	DH & DB
A^U = Bottom edge of operator	A⁰ = Upper edge of operator

The opening direction of the sliding door determines where the power supply (mains connection) is connected at the CS 80 MAGNEO. The cable that comes out of the wall should at least be 250 mm long. See drawing at bottom of page 8.

A^U describes the distance between the bottom edge of the CS 80 MAGNEO operator and the passage. You may select the dimension according to your requirements and will require it when planning your CS 80 MAGNEO as an on-wall mounted version.

The passage height DH and the passage width DB have to be determined when planning an automatic CS 80 MAGNEO sliding door system.





A⁰ describes the distance between the upper edge of the operator and the passage. You may select the dimension according to your requirements and will require it when planning your CS 80 MAGNEO as an in-wall mounted version.

CS 80 MAGNEO systems with door frame or baseboard projection (AW-dimension)

	<p>Is there a door frame or baseboard? If so, how big is the projection of the frame/baseboard with regard to the surface of the wall (AW) at its biggest point? In case the AW-dimension (projection) is bigger than 3 mm, you will have to shim the</p>	<p>CS 80 MAGNEO operator. DORMA offers a special shim plate for this purpose. In case the AW-dimension (projection) is bigger than 15 mm, the operator additionally has to be shimmed by others.</p>

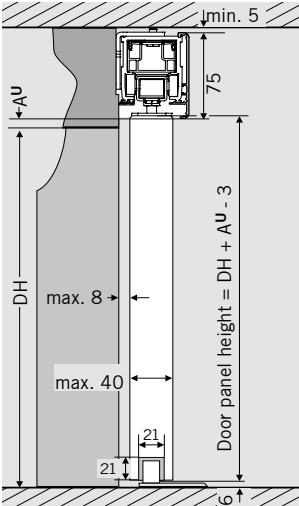
Please have a look at our CS 80 MAGNEO planning aid leaflet for further assistance during the planning your door system. If you are interested in this leaflet please contact your DORMA specialist dealer or visit us on the internet www.dorma-magneo.com.

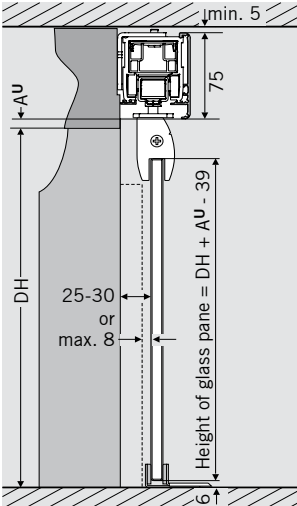
That's all you need: Required installation dimensions.

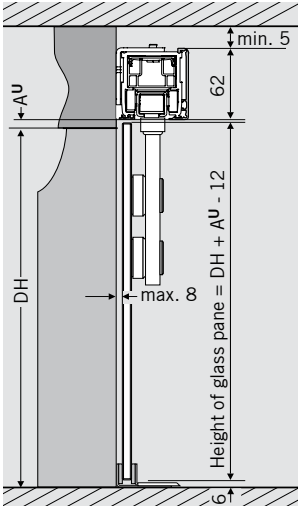
	Wooden door/frame door (on-wall)	Glass door/glass clamping rail (on-wall)	Glass door/ MANET single-point fixings (on-wall)
<p>When planning an automatic CS 80 MAGNEO door system, you may for example start with the door panel in order to create a smooth look with regard to the passage or to use an existing door panel.</p> <p>In some cases it might be reasonable to concentrate the planning on the fixing points of the operator as the fixing options provided by others are limited.</p>	 	 	 

Glaziers and joiners should keep these dimensions in mind.

How to order the door panel:

- The door panel is not a system component of the CS 80 MAGNEO modular system, you may place your order with a glazier or joiner.
- **Door panel width** is freely selectable between 650 mm and 1,255 mm. The door panel projection (A^B) must however not exceed 65 mm. (See page 8)
 - **Door panel height** is freely selectable (max. 3,000 mm) and calculated with the aid of the mounting height of the operator.
 - **Glass door panels** have to be made of safety glass and all glass edges have to be rounded off.
 - **Door panel weight** may amount to between 20 and 80 kg.
 - Wooden door panels and glass doors with MANET single-point fixings must be provided with drill holes and recesses before the system is mounted. The required **C-dimension** results from the prevailing length version (LV) of the operator:
LV 1: C = 575 mm
LV 2: C = 700 mm
LV 3: C = 825 mm

Preparation of wooden door panel

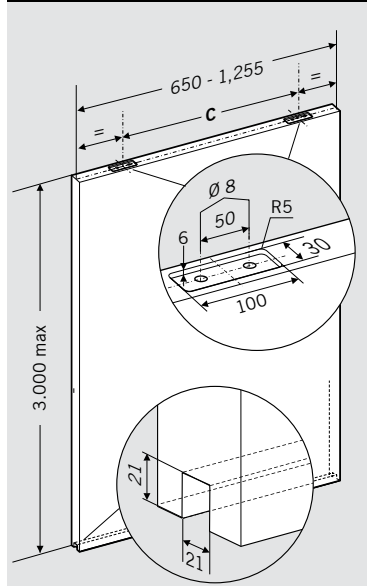

Glass door panel with glass clamping rail

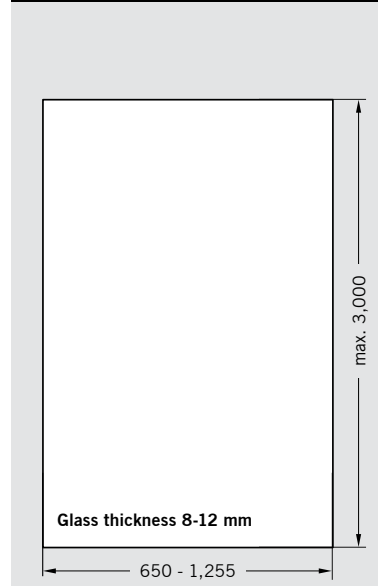

Glass door/ MANET single-point fixings*1 (on glass wall)	Wooden door/frame door (in-wall)	Glass door/glass clamping rail (in-wall)	Glass door/ MANET single-point fixings*2 (in-wall)	
				<p>*1 The system may only be planned and mounted by a properly qualified person. Please also have a look at the CS 80 MAGNEO leaflet for systems with glass fixings.</p> <p>*2 This application does not comply with European Union standards. There is a risk of injury in the panel-suspension area.</p>
<p>min. 5</p> <p>AU</p> <p>62</p> <p>DH</p> <p>max. 8</p> <p>Height of glass pane = $DH + AU - 12$</p> <p>6</p>	<p>55</p> <p>A0</p> <p>58</p> <p>69</p> <p>DH</p> <p>max. 8</p> <p>max. 8</p> <p>max. 40</p> <p>21</p> <p>21</p> <p>Door panel height = $DH + A0 - 75$</p> <p>6</p>	<p>55</p> <p>A0</p> <p>58</p> <p>105</p> <p>DH</p> <p>max. 8</p> <p>max. 8</p> <p>Height of glass pane = $DH + A0 - 111$</p> <p>6</p>	<p>55</p> <p>A0</p> <p>58</p> <p>65</p> <p>DH</p> <p>max. 8</p> <p>max. 8</p> <p>Height of glass pane = $DH + A0 - 71$</p> <p>6</p>	

Preparation of MANET glass door panel

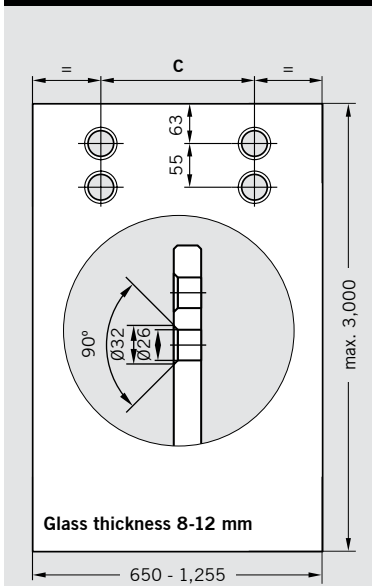

Preparation of optional recessed door grip

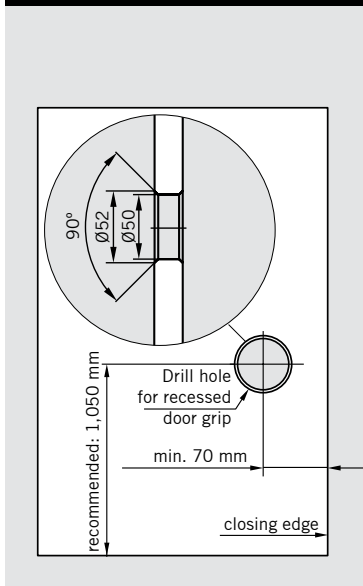

Hints regarding in-wall mounting

We would recommend covering the door panel connection at the CS 80 MAGNEO operator with profiles so that you will be able to access the operator easily even after the wall has been closed.

Furthermore you may use a special door frame by company **BOS**. Please contact the manufacturer for further details:

BOS Phone number:
+49 2572 203-0
Internet:
www.BestOfSteel.de

Please have a look at our CS 80 MAGNEO planning aid leaflet for further assistance during the planning your door system. If you are interested in this leaflet please contact your DORMA specialist dealer or visit us on the internet www.dorma-magneo.com.

Which system components do you require?

	Wooden door/frame door (on-wall)			Glass door/glass clamping rail (on-wall)			Glass door/ MANET single-point fixings (on-wall)		
	LV 1	LV 2	LV 3	LV 1	LV 2	LV 3	LV 1	LV 2	LV 3
A. Door kits	84000071			8400007-3	-4	-5	84000072		
B. Cover and fixing kit	8400005-1	-2	-3	8400005-1	-2	-3	8400006-1	-2	-3
Optional shim plate, if AW (projection) = 3 to 15 mm	8402012-4	-5	-6	8402012-4	-5	-6	8402012-4	-5	-6
C. CS 80 MAGNEO operator	8401000-1	-2	-3	8401000-1	-2	-3	8401000-1	-2	-3

The CS 80 MAGNEO is a modular system.

Combine your system components based on your installation requirements: CS 80 MAGNEO operator plus door kit and in case of on-wall mounting: plus cover kit and fixing kit. For some system components you must select the correct length version LV1 – LV3. The table shows which system components and kits are required for each way of mounting. Please note the article numbers in the ordering guide below.

Determining the required length version LV1 to LV3

The CS 80 MAGNEO operator, the fixing kit and cover kit as well as the door kit with glass clamping rail are available in three different lengths. The required length is determined via the driving path.

- LV1** for driving paths F of up to 875 mm,
- LV2** for driving paths F of up to 1,000 mm,
- LV3** for driving paths F of up to 1,125 mm.

Driving path F = passage width DB + door panel projection AB

DB =

AB =

F =

LV1 LV2 LV3

Driving path: on-wall mounting

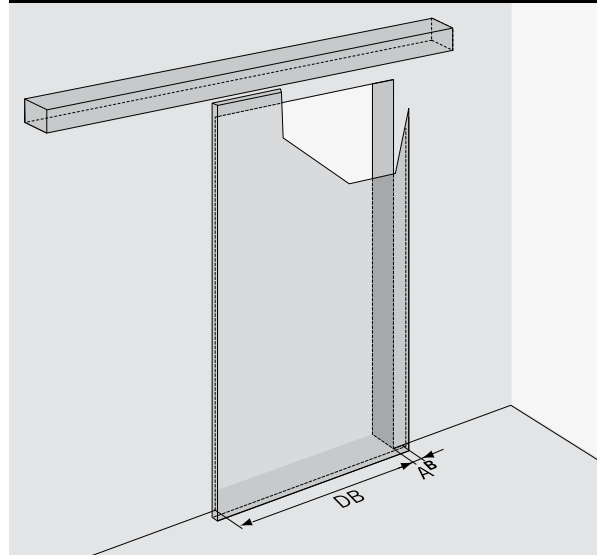

Glass door/ MANET single-point fixings*1 (on glass wall)			Wooden door/frame door (in-wall)			Glass door/glass clamping rail (in-wall)			Glass door/ MANET single-point fixings*2 (in-wall)			<p>*1 The system may only be planned and mounted by a properly qualified person. Please also have a look at the CS 80 MAGNEO leaflet for systems with glass fixings.</p> <p>*2 This application does not comply with European Union standards. There is a risk of injury in the panel-suspension area.</p>	
				LV 1	LV 2	LV 3	LV 1	LV 2	LV 3	LV 1	LV 2		LV 3
84000072	84000071	8400007-3	-4	-5	84000072								
8400006-1	-2	-3											
8401000-1	-2	-3	8401000-1	-2	-3	8401000-1	-2	-3	8401000-1	-2	-3		

CS 80 MAGNEO: Risk for the facility operator and risk assessment

The risk of crushing, shearing, hitting and drawing-in may not be excluded at automatic doors. When the system is delivered (in Low-Energy-Mode), the CS 80 MAGNEO meets the requirements of DIN 18650.

By complying with the provisions, such as reduced driving speeds and contact forces, the system generally provides a high safety standard so that sensors are not required as a rule. At the discretion of the operator or installer and

depending on the spatial conditions and the persons using the door, it may be advisable to use safety sensors even when the system is operated in Low-Energy-Mode, for instance if being used by children or older persons. For this purpose, a risk assessment must be carried out by a specialist firm when the door system is being planned and commissioned. It is at the operator's discretion whether or not a safety device is actually installed. In Full-Energy-Mode the use of additional safety sensors is obligatory.

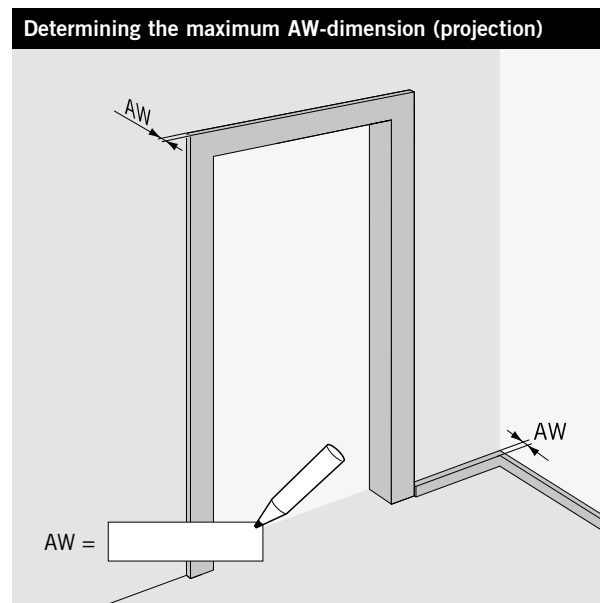
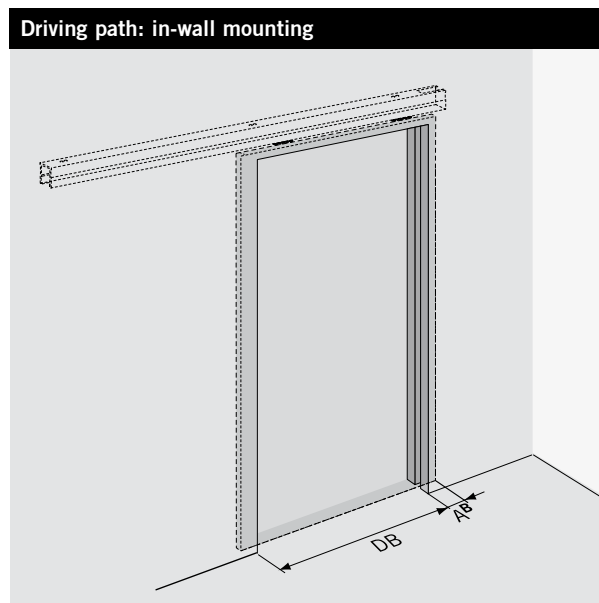

**Four steps to create your door system.
Then everything will work automatically.**

1. Measuring

Measure the passage and the required dimensions on site. Please consider the CS 80 MAGNEO planning aid leaflet to determine all important dimensions. If you are interested in this leaflet, please contact your DORMA specialist dealer or visit us on the internet: www.dorma-magneo.com.

2. Planning

Please determine the size of the planned door panel/door, the required length version LV and the position of the CS 80 MAGNEO. The information on pages 8 to 11 in this brochure will help you.

3. Select system components

The CS 80 MAGNEO is a modular system. The table on pages 12-13 indicates the required system components for all ways of mounting. Please enter the article numbers on the form on the back of this paper.

4. Order system components and door panels

Place an order for the desired CS 80 MAGNEO components with your authorised DORMA dealer. Please contact the glazier or joiner of your choice to order the suitable door panel. The technical specifications for the door panel on pages 10 and 11 will help you during the placement of your order.

Ordering guide. Almost ready: Your CS 80 MAGNEO.

Please enter the article numbers from the adjacent table.



1. What kind of door would you like to install?

A. Which door kit do you need?

B. Would you like to mount the CS 80 MAGNEO onto the wall? If so, you will require a cover and fixing kit. Which one?

Is the passage area equipped with a door frame and/or are there any baseboards?

Is the AW-dimension bigger than 3 mm? If so, you will need a shim plate.

C. Which length versions LV of the CS 80 MAGNEO operator do you require?

2. What kind of power supply would you prefer?

Direct power supply (flush-mounted) standard equipment

Via 230 V mains cable (please enter the article number from the page 15)

3. How would you like to open and close the door?

Automatic activation (opening) as soon as the door panel is pushed by hand (Push&Go) standard equipment

Recessed door grip for door panel (recommended with Push&Go Function) 84020100

Automatic activation (opening) via pushbutton (flush-mounted version, white) 19144701170

Automatic activation (opening) via ArtMotion motion detector Black 16614701170

..... Silver-coloured 16614702170

..... White 16614703170

Additional sensor fixing set (always order 1 set for ArtMotion motion detectors) 84020030

Automatic opening via radio control Receiver 29302001

..... Hand-held transmitter 29301001

..... Radio switch (wall-mounted) 29301002

Additional set of radio switches (always order 1 set for radio systems) 84020081

4. How would you like to adjust the function programs (Off, Automatic, Permanent Open)?

Adjustment of function programs via internal program switch (located at end cap) 16610601175

Adjustment of function programs via external program switch (EPS-S3, wall-mounted) 16605501150

Adjustment of "Permanent Open Function" via double-click on activator

(not possible with motion detectors such as ArtMotion) standard equipment

5. Do you require safety or presence sensors to safeguard the closing edges?

The limited driving speeds and the low contact force provide a high safety standard when the system is operated in the standard "Low-Energy-Mode" (system status of CS 80 MAGNEO on delivery). A risk assessment must be carried out during planning and commissioning to determine whether the use of additional sensors is required. The installation of additional sensors is optional and lies in the discretion of the facility operator. If the CS 80 MAGNEO is operated in extended "Full-Energy-Mode", the closing edges have to be additionally protected. The respective safety equipment has to be installed by a specialist for automatic door systems.

ACTIV8 ONE ON (motion detector & closing edge protection) 16576001170

IRIS ON (closing edge protection) 16588801170

JUPITER (motion detector & closing edge protection) 16563201170

JUPITER Presence (closing edge protection) 16591901170

Additional sensor fixing set (order one set per sensor) 84020030

For queries and orders relating to CS 80 MAGNEO system components, please contact:



Technical specifications

Operator length	without cover	with cover
Length version LV1	1,750 mm	1,840 mm
Length version LV2	2,000 mm	2,090 mm
Length version LV3	2,250 mm	2,340 mm

Operator height

With MANET single-point fixings	62 mm
With glass clamping rail	75 mm
With wooden door panel	75 mm

Overall depth

On-wall mounting (without shim plate)	60 mm
In-wall mounting (only operator profile)	50 mm

Operator weight

Length version LV1	8.6 kg
Length version LV2	9.4 kg
Length version LV3	10.2 kg

Speed

0.2–0.6 m/s

The speed is calculated with the aid of the driving path and the door panel weight. During the commissioning, the system will adjust automatically in accordance with the prevailing standards and regulations.

Power supply

220–230 V AC ± 10% 50/60 Hz

Fuse protection, by others

10 A

Power consumption

Stand-by-mode	3.7 W
Automatic Function	max. 60 W

Class of protection

IP 20

Temperature range

0–40 °C

Operating noise

max. 55 db (A)

Measured at test setup. The noise level depends on the door and the prevailing substructure.

Low-Energy-Mode

●

Full-Energy-Mode

○

Compliant with DIN 18650, ANSI, BSI

●

Manufactured to ISO 9001:2000

●

Connectable accessory

Pushbutton, radio remote control and radio switch

●

Motion detector

●

External program switches

●

Safety sensors for main and secondary closing edge

●

● = yes ○ = optional

DORMA system components of the modular system

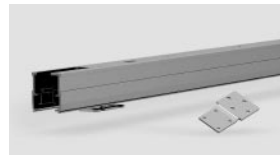

CS 80 MAGNEO operator

incl. set for in-wall mounting

LV1	Art.-No. 84010001
LV2	Art.-No. 84010002
LV3	Art.-No. 84010003

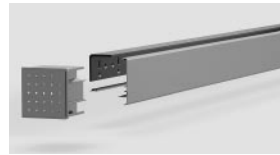

Cover and fixings kit for wooden door panels and glass clamping rail

LV1	Art.-No. 84000051
LV2	Art.-No. 84000052
LV3	Art.-No. 84000053

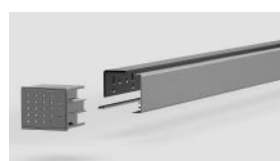

Cover and fixings kit for MANET

LV1	Art.-No. 84000061
LV2	Art.-No. 84000062
LV3	Art.-No. 84000063

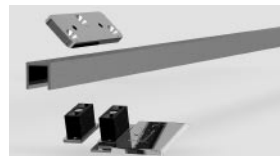

Door kit for wooden door panel

incl. floor guides
Art.-No. 84000071



MANET door kit

incl. floor guides
Art.-No. 84000072

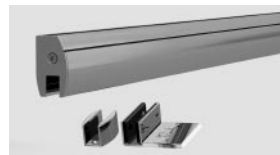

Door kit for glass clamping rail

incl. floor guides E6/C0
LV1 Art.-No. 84000073
LV2 Art.-No. 84000074
LV3 Art.-No. 84000075
Aluminium profile, mill finish
LV3 Art.-No. 84000076



Shim plate

LV1	Art.-No. 84020124
LV2	Art.-No. 84020125
LV3	Art.-No. 84020126



Recessed door grip for wooden or glass doors

Art.-No. 84020100

Profiles in stock lengths 6,250 mm

Mounting profile for glass-fixing system Mill-finish Art.-No. 34002701120
E6/CO Art.-No. 34002702120

Fixing profile for glass-fixing system Art.-No. 34002801120

Cover profile for glass-fixing system Mill-finish Art.-No. 34002901120
E6/CO Art.-No. 34002902120

Internal cover 75 mm Mill-finish Art.-No. 34003003120
E6/CO Art.-No. 34003002120

Internal cover 62 mm Mill-finish Art.-No. 34003103120
E6/CO Art.-No. 34003102120

Distance profile Art.-No. 34003401120

Operator profile Art.-No. 34002502120

Accessories: Operator and door panel

Set for in-wall mounting Art.-No. 84020002

Set for on-wall mounting LV1 Art.-No. 84020003
LV2 Art.-No. 84020004
LV3 Art.-No. 84020005

Set for on-wall mounting (for glass walls) Art.-No. 84020006

Mains cable for
Germany 230 V Art.-No. 84020040
UK 230 V Art.-No. 84020041
USA 115 V Art.-No. 84020042
Italy 230 V Art.-No. 84020043
Denmark 230 V Art.-No. 84020044
Switzerland 230 V Art.-No. 84020045
Australia 230 V Art.-No. 84020046
South-Africa 230 V Art.-No. 84020047

End caps
Height 62 mm Mill-finish Art.-No. 84020070
E6/CO Art.-No. 84020071
Height 75mm Mill-finish Art.-No. 84020073
E6/CO Art.-No. 84020074

Cover profile set for wall connection Art.-No. 84020090

Guide rail for wooden door panels 1,125 mm
Art.-No. 84020112

Floor guide for in-wall mounting
For wooden door panels Art.-No. 84020123
For glass door panels Art.-No. 80732600099

Floor guide on metal sheet (frame) Art.-No. 92212001

External floor guide rail (glass) Art.-No. 33438001150

Pushbuttons and program switches



Pushbutton, flush-mounted design, white
Art.-No. 19144701170

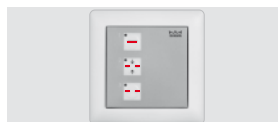

Program switch EPS-S3
Art.-No. 16605501150

Internal program switch
(no picture)
Art.-No. 16610601175

Comfort switch with RC radio technology



RC receiver
Art.-No. 29302001



Additional set of radio switches
(always required for radio systems, no picture) Art.-No. 84020081



RC-H hand-held transmitter
Art.-No. 29301001

RC-W large-surface pushbutton
Art.-No. 29301002

Motion detectors and sensors



ACTIV8 ONE ON
Motion detector and closing edge protection
Art.-No. 16576001170



IRIS ON
Closing edge protection
Art.-No. 16588801170



JUPITER
Motion detector and closing edge protection
Art.-No. 16563201170

JUPITER Presence
Closing edge protection
Art.-No. 16591901170

ArtMotion radar motion detector
White Art.-No. 16614703170
Silver-coloured Art.-No. 16614702170
Black Art.-No. 16614701170

Additional sensor fixing set
(order one set per sensor, no picture) Art.-No. 84020081

DORMA GmbH + Co. KG
DORMA Platz 1
D-58256 Ennepetal
Phone +49 2333/793-0
Fax +49 2333/793-495

Division Automatic weltweit

Region Australasia

Australia
DORMA Automatics Pty. Ltd.
Phone +61 3 97964111
www.dorma.com.au

New Zealand
DORMA HORIZON NZ LTD
Phone +64 9 573-1999
www.dorma.com.nz

Region Central Europe

Belgium
DORMA foquin N.V./S.A.
Phone +32 50 451570
www.dorma.be

Germany
DORMA Automatic
GmbH + Co. KG
Phone +49 2333 793-0
www.dorma.de

Luxembourg
Luxembourg Subsidiary
Automatic
Phone +49 2333 793-216
www.dorma.de

Netherlands
DORMA van Duin Nederland B.V.
Phone +31 488 418100
www.dorma.nl

Switzerland
DORMA Schweiz AG
Phone +41 718864646
www.dorma.ch

Region Emerging Markets

Bulgaria
DORMA-BALKAN EOOD
Phone +359 2 9714 904
www.dorma.com

Greece
DORMA Representation Greece
Phone: +30 21 09944388
www.dorma.com

India
DORMA Door Controls India
Pvt. Ltd.
Phone +91 44 28585097
www.dorma.com

Israel
DORMA GmbH + Co. KG
Phone +49 2333 793-0
www.dorma.com

Poland
DORMA Polska sp. z o.o.
Phone +48 22 7365900
www.dorma.pl

Russia
DORMA Russia
Phone +7 495 981-1433
www.dorma.rus

South Africa
DORMA Door Controls (Pty.) Ltd
Phone +27 11 8300280
www.dorma.com

Turkey
DORMA Kapi Kontrolleri Ltd.
Sti Sahraticedid Mah.
Phone: +90 216 3600056
www.dorma.com

Ukraine
DORMA Sales Representative
Vasyl Stuchylin
Phone +38 44 5183526
www.dorma.com

Region China

China
DORMA China Ltd.
Phone +86512 67612481
www.dorma.com.sg

Hong Kong
DORMA Door Controls (Suzhou)
Co., Ltd.
Phone +852 25034632
www.dorma.com.sg

Region Far East

Indonesia, Japan, Malaysia,
Vietnam
DORMA Emerald Entrance
Systems Pte Ltd
Phone +65 459 5733
www.dorma.com.sg

Philippines
DORMA Door Controls Pte. Ltd.
Phone +632 893 4077/8
www.dorma.com.sg

Singapore
DORMA Far East Pte. Ltd.
(Sales)
Phone +65 64151898
www.dorma.com.sg

South Korea
DORMA Emerald Entrance
Systems Pte Ltd
Phone +65 459 5733
www.dorma.com.sg

Taiwan
DORMA Door Controls Pte. Ltd.
Phone +886 2 9182987
www.dorma.com.sg

Region France

France
DORMA Accueil S.A.S.
Phone +33 4 79348924
www.dorma.fr

Region Gulf

Saudi Arabia
DORMA Arabia Automatic
Doors Ltd.
Kingdom of Saudi Arabia
Phone +9663 847 2394
www.dorma.com

United Arab Emirates
DORMA Gulf Door Controls FZE
Dubai, United Arab Emirates
Phone +971 48 839014
www.dorma.com

Region North America

Canada
DORMA Door Controls
Phone +1 905 6701281
www.dorma.com

Mexico
DORMA México, S. de R.L.
de C.V.
Phone +52 55 5272-6937
www.dorma.com

USA
DORMA Automatics Inc.
Phone +1 847 295-2700
www.dorma-usa.com

Region Scanbalt

Denmark
DORMA Danmark A/S
Phone +45 44 543000
www.dorma.dk

Estonia
DORMA Representation
Estonia
Phone +372 6707064
www.dorma.com

Finland
DORMA Finland Oy
Phone +358 9 8789130
www.dorma.fi

Lithuania
DORMA Norge AS
Phone +47 23 176800
www.dorma.com

Norway
DORMA Norge AS
Phone +47 23 176800
www.dorma.no

Sweden
DORMA Sverige AB
Phone +46 31 289520
www.dorma.se

Region South America

Argentina
DORMA Sistemas de
Controles para Puertas Ltda
Phone +54 11 45051032
www.dorma.com

Brazil
DORMA Sistemas de Controles
para Puertas Ltda.
Phone +55 11 46899128
www.dorma.com.br

Region South-East Europe

Austria
DORMA AKS
Automatic GmbH
Phone +43 6225 8636-0
www.dorma.at

Croatia
DORMA Croatia d.o.o.
Phone +385 0 1 46 06 944
www.dorma-croatia.hr

Czech Republik
DORMA dverni technika CR,
s.r.o.
Phone +420 2 671321-78
www.dorma.com

Hungary
DORMA AKS Automatic GmbH
Phone +36 1 2065127
www.dorma.com

Romania
DORMA Romania S.R.L.
Phone +40 31 806 916 0
www.dorma.com

Slovakia
DORMA Slovensko spol. s.r.o.
Phone +421 2 50221-283
www.dorma.com

Slovenia
DORMA Representation Slove-
nia ICL d.o.o.
Phone +386 2 5302010
www.dorma.com

Region South Europe

Italy
DORMA Italiana S.r.l.
Phone: +39 039 244031
www.dorma.it

Portugal
DORMA Portugal
para Puertas, Lda.
Phone +351 252 860490
www.dorma.com

Spain
DORMA Ibérica, S.A.
Phone +34 91 8757850
www.dorma.es

Region UK/Ireland

Ireland
DORMA Ireland Limited
Phone +353 1 295-8280
www.dorma.com

Great Britain
DORMA UK Limited
Phone +44 1462 477600
www.dorma-uk.co.uk



Door Control



Automatic



Glass Fittings



Security (STA)



Movable Walls